

ShenZhen Yes-Display International Technology CO.,LTD. 深圳市亿显国际科技有限公司			2.8 Inch UART Display Module 2.8 寸串口显示屏	
File NO.		REV	A/01	<a href="http://www.yes-display.com">http://www.yes-display.com</a>

# JART Display Module

**Module: YS-CB-0280LT08M-02 V1.0**

Designed by	R&D Checked by	Quality Department by	Approved by

Approval by Customer:

OK

NG, Problem survey

Approved By \_\_\_\_\_

ShenZhen Yes-Display International Technology CO.,LTD. 深圳市亿显国际科技有限公司			2.8 Inch UART Display Module 2.8 寸串口显示屏	
File NO.		REV	A/01	<a href="http://www.yes-display.com">http://www.yes-display.com</a>

## Revision Record

REV NO.	REV DATE	Contents Before Change	Contents After Change	Note
V1.0	2022/05/17	NEW		

ShenZhen Yes-Display International Technology CO.,LTD. 深圳市亿显国际科技有限公司			2.8 Inch UART Display Module 2.8 寸串口显示屏	
File NO.		REV	A/01	<a href="http://www.yes-display.com">http://www.yes-display.com</a>

## Contents

List	Description	Page No.
	Cover	1
	Revision Record	2
	Contents	3
1	Hardware Introduction	6
2	Product Application Diagram	7
3	Outline Dimensions	10
4	Interface Definition	11
5	Product technical parameters	12
6	Reliability Test Conditions and Methods	14
7	PC Software	15
8	Packing Method	16

ShenZhen Yes-Display International Technology CO.,LTD. 深圳市亿显国际科技有限公司			2.8 Inch UART Display Module 2.8 寸串口显示屏	
File NO.		REV	A/01	<a href="http://www.yes-display.com">http://www.yes-display.com</a>
1. Hardware Introduction				

### 1.1 Hardware Introduction



ShenZhen Yes-Display International Technology CO.,LTD. 深圳市亿显国际科技有限公司			2.8 Inch UART Display Module 2.8 寸串口显示屏	
File NO.		REV	A/01	<a href="http://www.yes-display.com">http://www.yes-display.com</a>

**2. Product Application Diagram**

**2.1 Chip-set Introduction**

UART chip-set is an efficient Serial Uart TFT Panel controller. Its internal combination of YES-DISPLAY's 32bit MCU and TFT graphics accelerator, The main function is to provide Uart, USB serial port communication, so that the upper computer MCU can easily display the content to the TFT panel to the TFT driver through simple command. In addition, the internal hardware also provides graphics acceleration, PIP (picture-in-picture), geometric graphics drawing and other functions, which can improve TFT display efficiency and reduce the time spent by MCU in processing graphics display. The CPU supports TFT display resolution 320\*240 (QVGA), and the display supports 8bits Mcu / SPI interface.

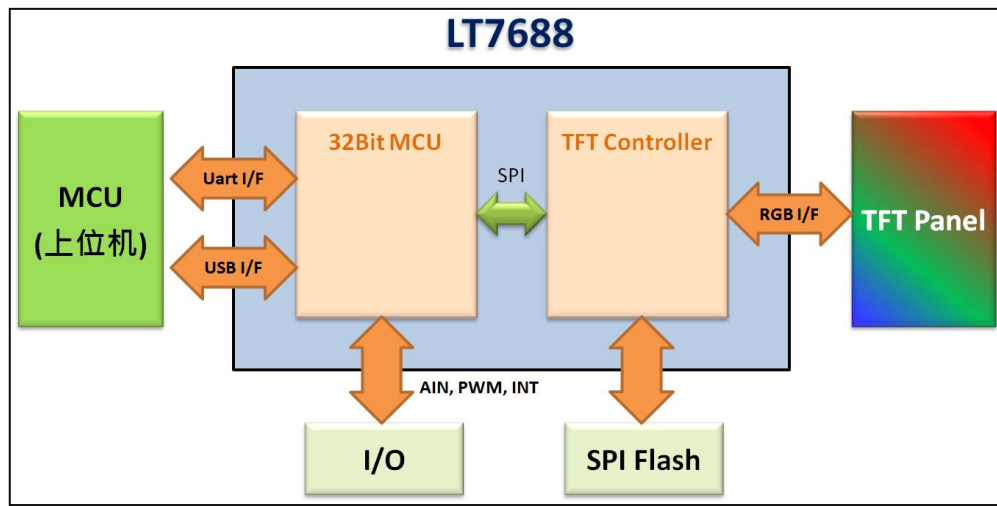

Figure 1-1: Application Block Diagram

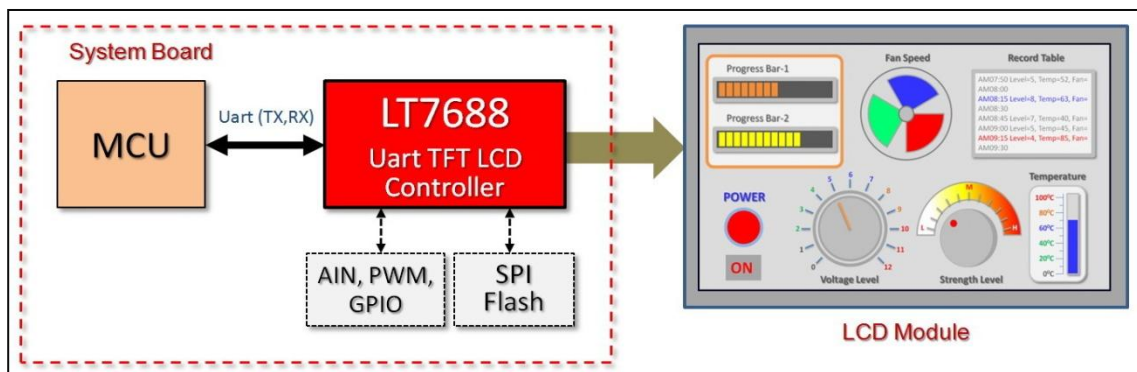

Figure 1-2: Applications – 1

ShenZhen Yes-Display International Technology CO.,LTD. 深圳市亿显国际科技有限公司			2.8 Inch UART Display Module 2.8 寸串口显示屏	
File NO.		REV	A/01	<a href="http://www.yes-display.com">http://www.yes-display.com</a>

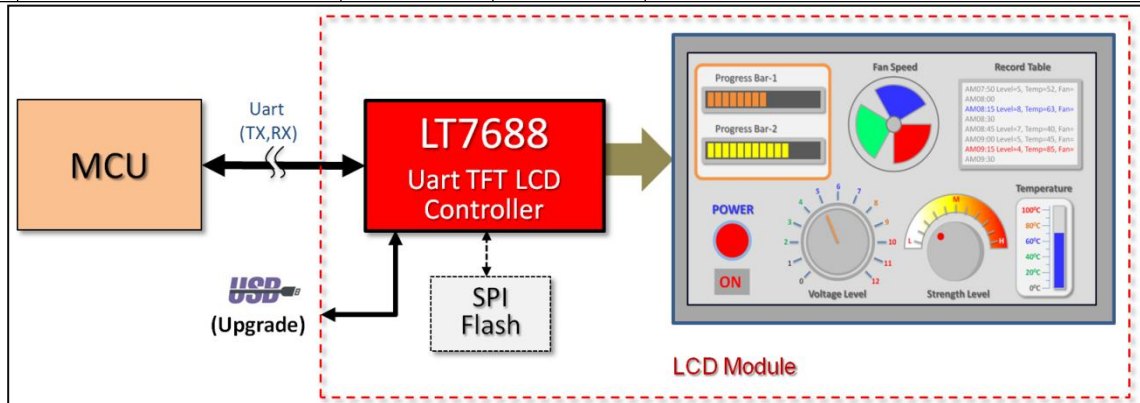

Figure 1-3: Applications – 2

The serial Uart TFT panel of YS7688 also supports the data update of the internal core main program of YS7688 or SPI Flash through the USB interface. Please refer to the schematic diagram and Chapter 6 of the AP note.

The "TFT Panel" that mentioned below in this application note are means "Serial Uart TFT Panel".

## 2.1 The Frame of Serial Uart Interface Panel

Serial Uart interface panel is added MCU and TFT controller on the TFT display module, the MCU is responsible for receiving from the remote mainboard interface port (Uart) command, then based on the defined commands to show images or animations, remote motherboard MCU don't need to write complex applications for showing images.

TFT Panel and remote MCU mainly communicate through RS232 or RS485 interface. If the distance between the remote MCU and TFT Panel is very close (~30cm), the Uart output and input of the remote MCU can be directly connected to the TFT panel, as shown in the following diagram:

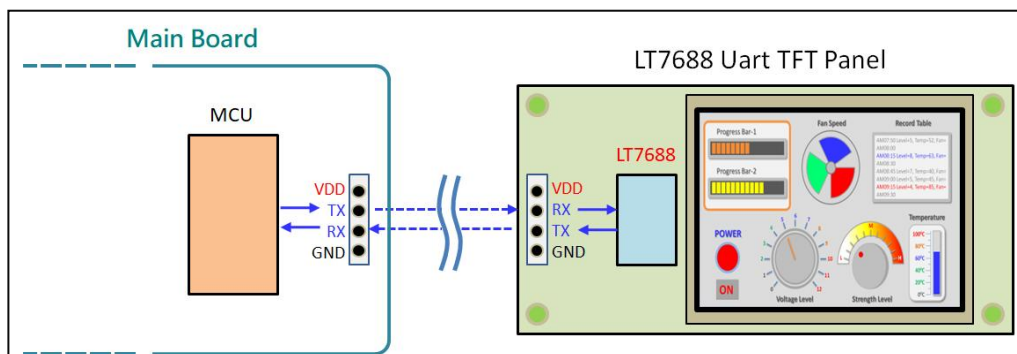

Figure 1-4: Connection Diagram - 1

In order to guarantee the communication effect over a long distance, the special driver chip of RS232 or RS485 is usually needed. As shown in the following diagram:



ShenZhen Yes-Display International Technology CO.,LTD. 深圳市亿显国际科技有限公司			2.8 Inch UART Display Module 2.8 寸串口显示屏	
File NO.		REV	A/01	<a href="http://www.yes-display.com">http://www.yes-display.com</a>

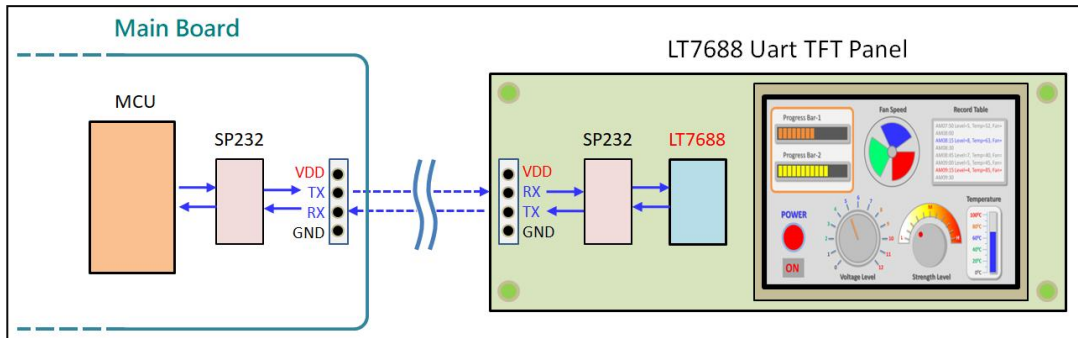

Figure 1-5: Connection Diagram - 2

Before using a TFT panel needs to be developed by computer develop software, Yes-Display provides (UartTFT\_Tool.exe) and (UI\_Editor.exe), both develop tools are for PC/NB on Windows environment, and can set up and develop TFT panel separately. When developing with them, Bin files will be generated for images, texts, animations and other information. Developers must burn Bin files into SPI Flash through SPI Flash programmer. Then through USB to Uart (RS232) to simulate the display screen of TFT panel. That is to do the early verification of TFT panel display screen.

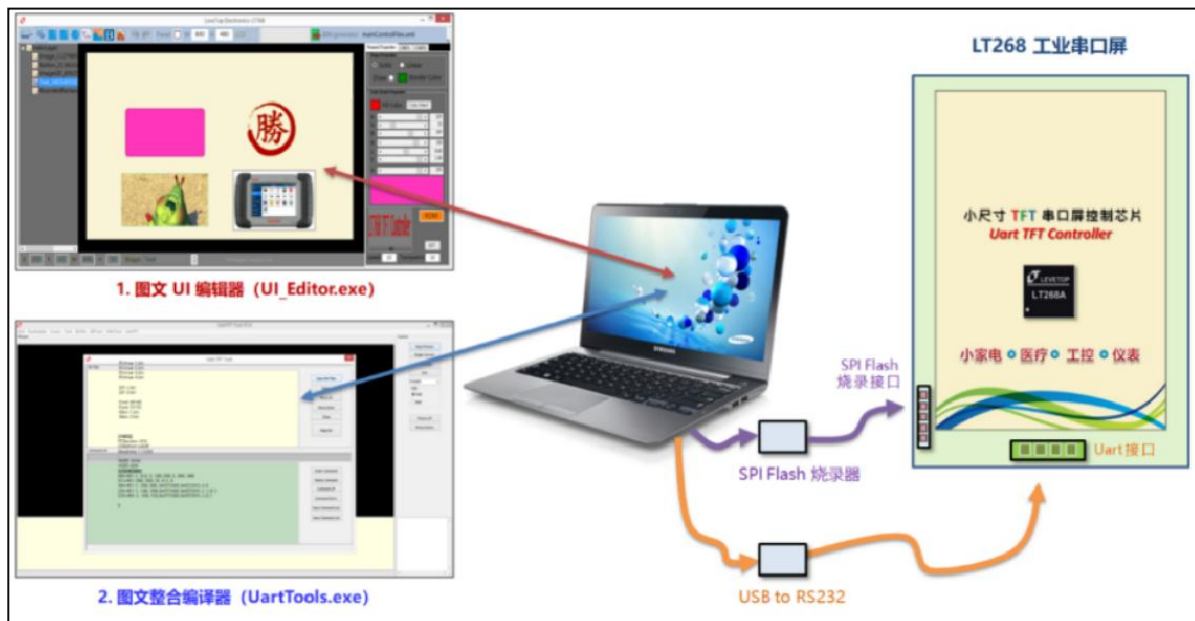

Figure 1-6: Schematic Diagram Of Developed By Using Yes-Display's Develop Tools

The develop tool generates commands based on the order and manner in which the images appear. The simulation mentioned above is to replace the remote master control with a computer to send out commands, allowing developers to do early verification on the develop tools. If the instructions send by the develop tools can be displayed on the TFT

ShenZhen Yes-Display International Technology CO.,LTD. 深圳市亿显国际科技有限公司			2.8 Inch UART Display Module 2.8 寸串口显示屏	
File NO.		REV	A/01	<a href="http://www.yes-display.com">http://www.yes-display.com</a>

panel and achieve the desired effect of the developer, then the remote host will eventually implant these instructions in its MCU program and send corresponding commands when it wants to display images. Figure 1-7 below is the schematic diagram of connection between the main control board and the TFT Panel:

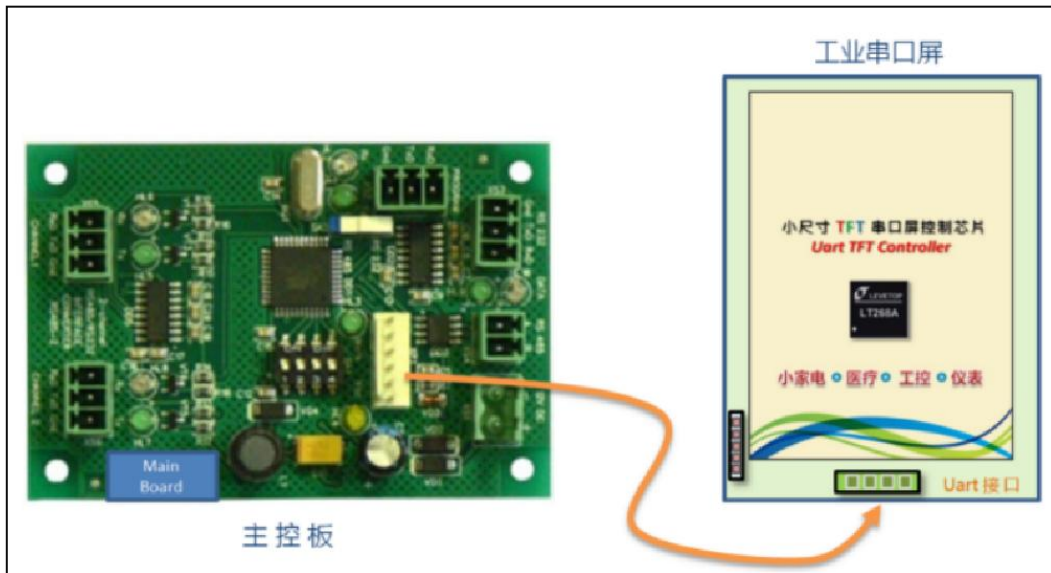

Figure 1-7: Connection Between Remote Main Control Board And TFT Panel

UartTFT\_Tool has a fixed command for each display action. For example, 80h is the command to display images, UartTFT\_Tool will number the images and produce Bin files for all the pictures, text, animation and other information after compiling. Developers will Bin file after burn in the SPI Flash, when the computer is sent out 80h、00h, then TFT panel will show the first image; sent out 80h、01h will display the second image. When the commands from UartTFT\_Tool can achieve the desired effect on the serial panel, the remote master can be connected to the TFT panel. When the remote MCU program sends 80h, 00h, 1Bh(CRC1), 98h(CRC2), the serial panel will display the first image, and send back messages 80h, 00h(execution completed), 1Bh(CRC1), 98h(CRC2) to the remote host to confirm the completion of the entire command, as shown below:

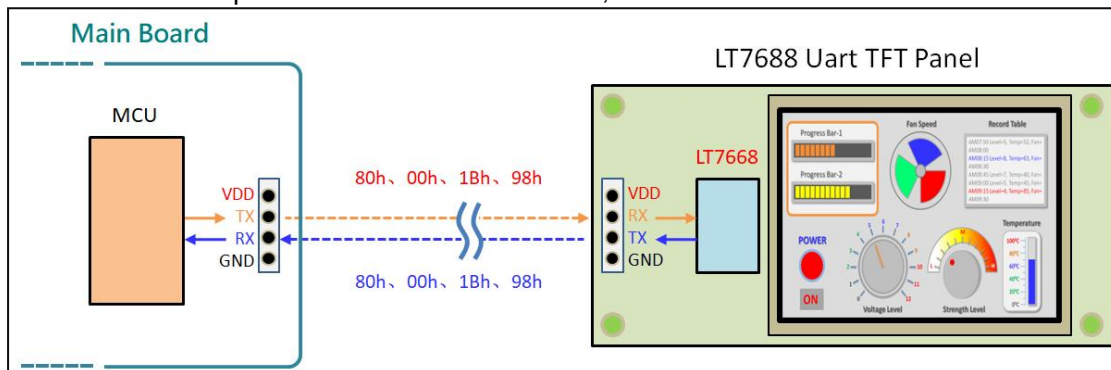

Figure 1-8: Command Protocol - 1

When the remote MCU program sends 80h, 01h, 1Bh(CRC1), 98h(CRC2), the serial panel



ShenZhen Yes-Display International Technology CO.,LTD. 深圳市亿显国际科技有限公司			2.8 Inch UART Display Module 2.8 寸串口显示屏	
File NO.		REV	A/01	<a href="http://www.yes-display.com">http://www.yes-display.com</a>

will display the second image, and send back messages 80h, 00h(execution completed), 1Bh(CRC1), 98h(CRC2) to the remote host to confirm the completion of the entire command, as shown below:

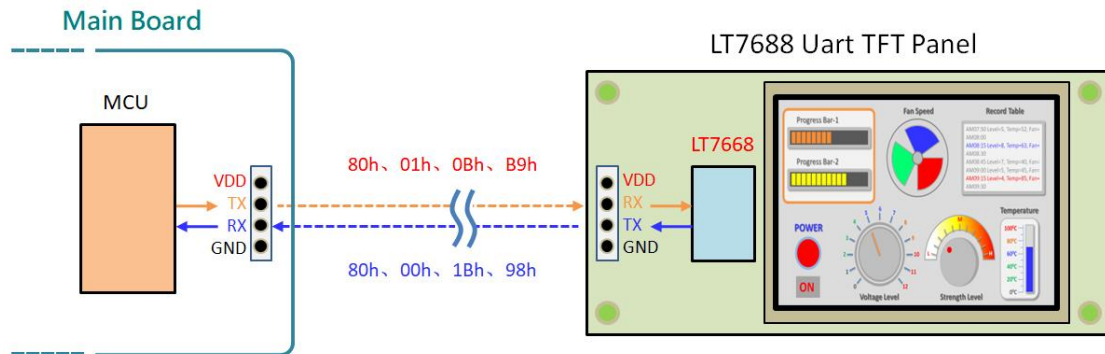
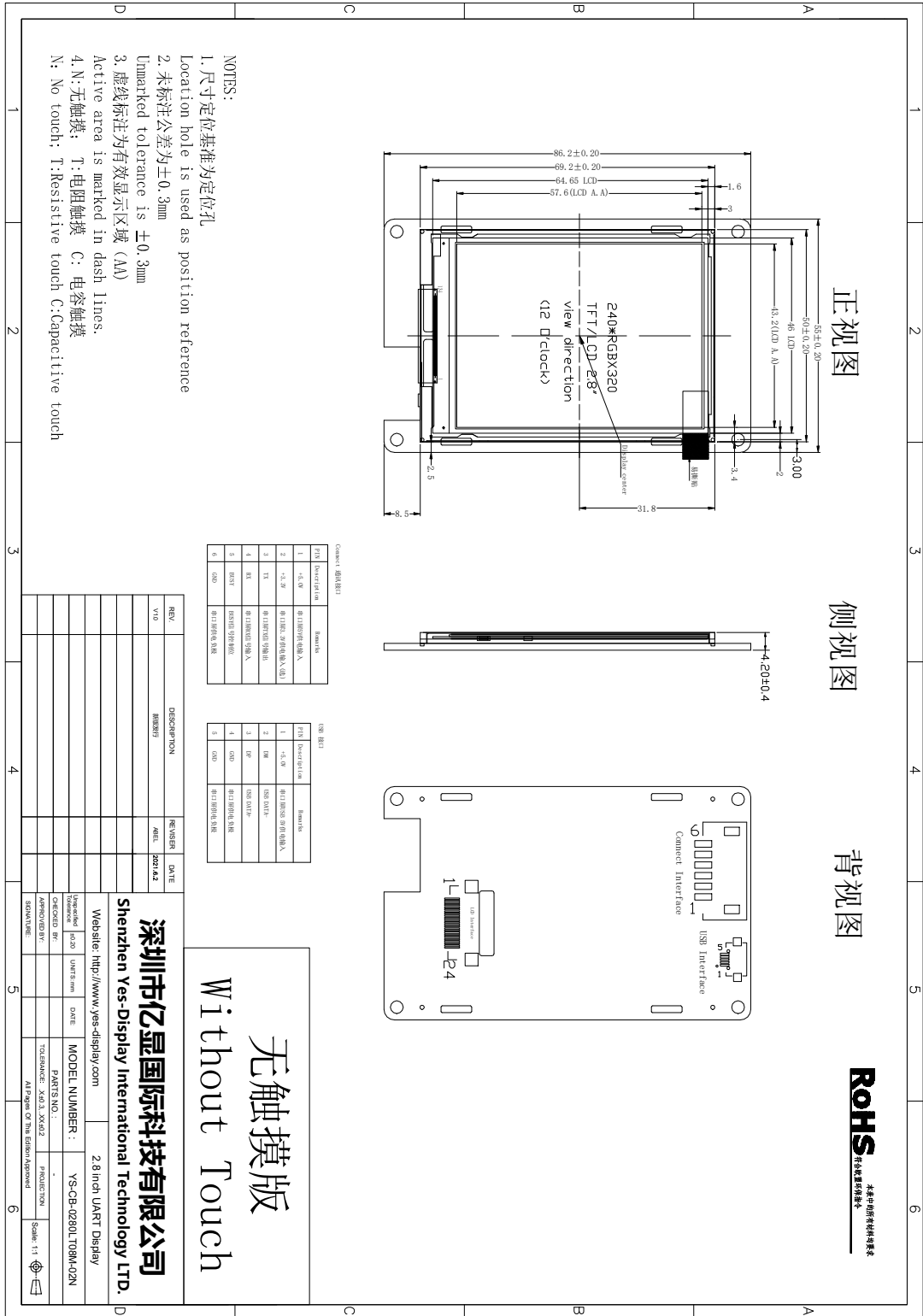

Figure 1-9: Command Protocol - 2

Tip: in order to ensure that the data transmission between remote control and TFT panel is correct, the remote control MCU program sent out orders need to add 1 Byte starting code (fixed 0xaa), 2 Byte CRC code, 4 Byte ending code (fixed 0xE4, 0x1B, 0, 0x11, 0xEE). When the TFT Panel receives the message or completes the command, it will send back the message to the MCU of the remote host. For the protocol table of command between the remote host and the TFT Panel, please refer to Section 2.2 below in the AP note. Refer to Section 2.3 later in the AP note for the generation of 2-byte CRC.

The TFT Panel can also be used to update the internal core main program of YS7688 or SPI Flash with USB. Please refer to the schematic diagram in the next Section and Chapter 6 of the AP note.

3. Outline Dimensions



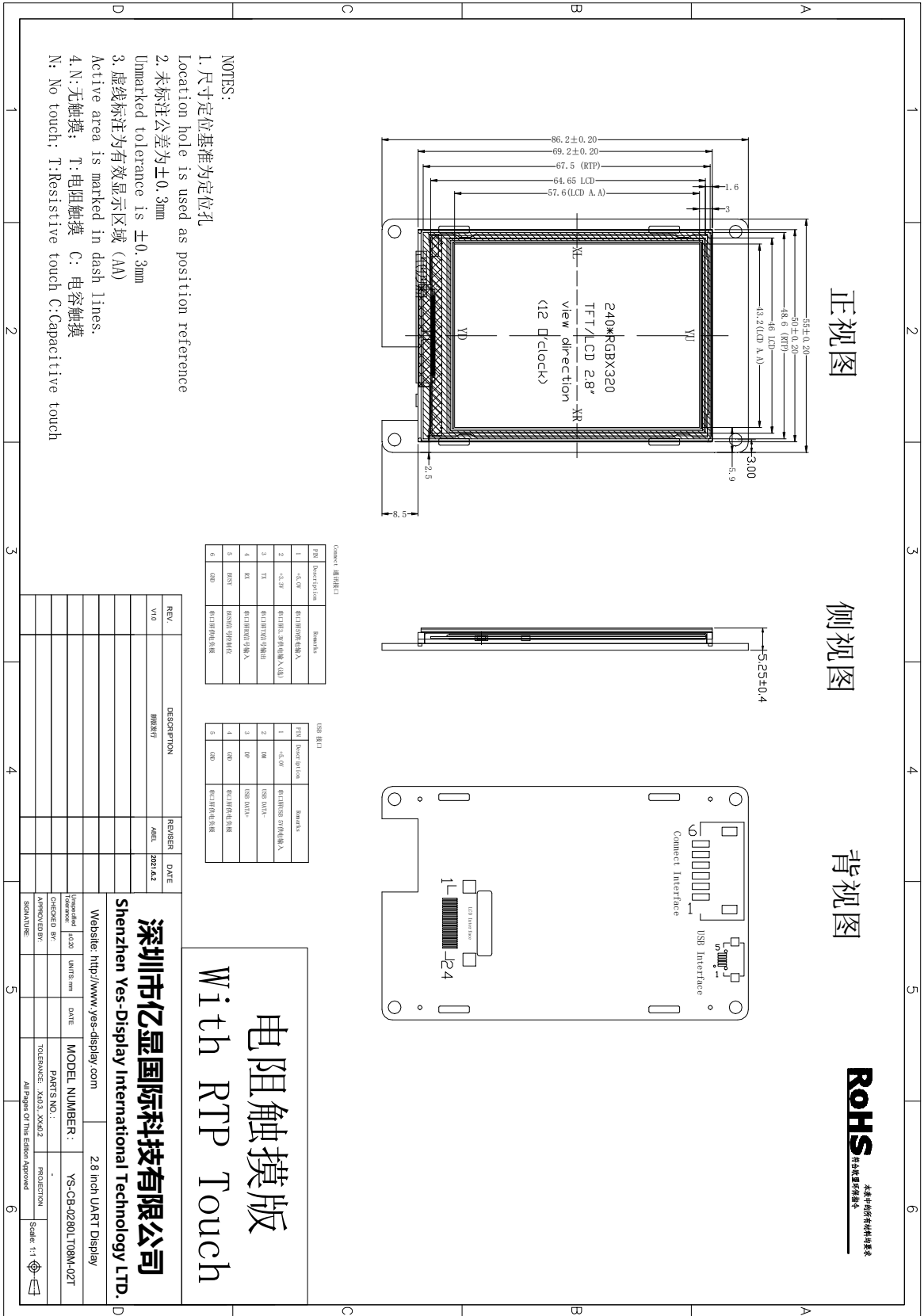

ShenZhen Yes-Display International Technology CO.,LTD. 深圳市亿显国际科技有限公司			2.8 Inch UART Display Module 2.8 寸串口显示屏	
File NO.		REV	A/01	<a href="http://www.yes-display.com">http://www.yes-display.com</a>

#### 4. Interface Definition

##### 4.1 Connect Interface Definition

PIN	Definition	Functional Description
1	+5.0V	Module +5.0V input
2	+3.3V	Module +3.0V input
3	TX	UART(TTL) TX single
4	RX	UART(TTL) RX single
5	BUSY	UART update IO, connect to GND when updating
6	GND	Power ground

##### 4.2 USB Interface Definition

PIN	Definition	Functional Description
1	+5.0V	USB +5.0V input
2	D-	USB DATA-
3	D+	USB DATA+
4	GND	Power ground
5	GND	Power ground

ShenZhen Yes-Display International Technology CO.,LTD. 深圳市亿显国际科技有限公司			2.8 Inch UART Display Module 2.8 寸串口显示屏	
File NO.		REV	A/01	<a href="http://www.yes-display.com">http://www.yes-display.com</a>

## 5. Product Technical Parameters / 产品技术参数

### 5.1 Product Parameters / 产品参数

MCU Chip-Set	核心处理器	32 ARM MCU	32 位双核处理器
Protocol type	协议类型	UART/TTL	UART/TTL 组态指令集
Size	尺寸	2.8 inch	2.8 寸
Resolution	分辨率	240*320	240*320
Storage Space	存储空间	8Mbit	8Mbit
Font library	字库	Built-in vector font, edge anti-aliasing processing, including any size bitmap ASCII, GBK, GB2312,	内置矢量字体, 边缘抗锯齿处理, 包含任何大小点阵 ASCII、GBK、GB2312、字库;
Photo storage	图片存储	Support JPEG, PNG (half through/full through) compression, support arbitrary size image storage, support image rotation, zoom, zoom and other functions. The image compression ratio is different, this value will float up and down;	支持 JPEG、PNG (半透/全透) 压缩, 支持任意大小图片存储, 支持图片旋转、放大、缩小等功能。图片压缩比不同, 此值会上下浮动;
color	颜色	65K, 16Bit RGB	65K 色, 16 位 RGB
voltage	电压	5.0V /3.3V	5.0V /3.3V
Power consumption	功耗	Back Light Power ON: 3.5W; Back Light Power off: 1.6W	背光最亮: 3.5W; 关背光: 1.6W
Communication interface	通讯接口	RS232/TTL(Default TTL)	RS232/TTL(出厂默认 TTL)
Interface Specification	接口规格	PH2.54-6P	标准:PH2.54-6P
Images download	图片下载	UAR	UAR
RTC	实时时钟 (RTC)	—	—
PC software	配套上位机软件	YS_UI_Editor_V3.0	YS_UI_Editor_V3.0

### 5.2 LCD Display parameters / LCD显示屏参数

LCD type	显示器类型	2.8 inch display	TFT 2.8 寸液晶显示屏
Back light	背光灯管	LED	LED
brightness (cd/m <sup>2</sup> )	亮度 (cd/m <sup>2</sup> )	220	220
Back light life time (h)	背光灯寿命 (h)	>20,000	>20,000
contrast	对比度	400:1	400:1

ShenZhen Yes-Display International Technology CO.,LTD. 深圳市亿显国际科技有限公司			2.8 Inch UART Display Module 2.8 寸串口显示屏	
File NO.		REV	A/01	<a href="http://www.yes-display.com">http://www.yes-display.com</a>

View Angle (L/R/T/B)	视角 (L/R/T/B)	70/70/60/70	70/70/60/70
----------------------	--------------	-------------	-------------

### 5.3 Touch Panel Parameters / 触控面板参数

Touch panel type:	触控类型:	RTP	电阻触摸屏
Touch Way:	触控方式:	-	-
Light Transmittance:	透光率:	-	-
Touch Times	触控次数	-	-

### 5.4 Product application characteristics / 产品应用特点

Learning cycle	学习周期	10 minutes to get familiar with the development environment, 1 day to complete the man-machine interaction design	10 分钟熟悉开发环境, 1 天完成人机交互设计
Program debugging	程序调试	The host computer is integrated with a "virtual serial port screen", which requires no hardware connection.	上位机集成了“虚拟串口屏”, 无需连接硬件,
Start-up time	启动时间	Power on the run, no system load time	上电即运行, 无系统加载时间
Configuration control	组态控件	Has buttons, text, drop-down menu, progress bar, slider, instrument, animation, two-dimensional code, curve, circular progress bar and other configuration controls	拥有按钮、文本、下拉菜单、进度条、滑块、仪表、动画、二维码、曲线、圆形进度条等各种组态控件
Online upgrade	在线升级	Support screen engineering picture, firmware, user MCU firmware online USB upgrade	支持屏幕工程图片、固件、用户 MCU 固件在线 USB 升级
Layer technology	图层技术	System built-in multiple display layers, switching faster	系统内置多个显示图层, 切换速度更快
reliability	可靠性	The products have passed the industry standard high and low temperature, ESD, group pulse and radiation tests	产品均通过行业标准的高低温、ESD、群脉冲和辐射等测试
Life time	生命周期	In stock	持续稳定供货, 不断货

### 5.5 Environmental testing and certification / 环境实验与认证

operating temperature	工作温度	-20~+70°C	-20~+70°C
Storage temperature	存储温度	-30~+80°C	-30~+80°C
Vibration test	震动测试	10 to 25Hz(X,Y,Z direction 2G 30)	10 to 25Hz(X, Y, Z 方向 2G 30 分钟)
ESD Test	ESD 测试	Air=±8KV, Contact=±4KV	Air=±8KV, Contact=±4KV (常规指标, 可支持更高)
High and low temperature test	高低温测试	The experimental temperature:60°C±3°C 72H/-10°C±3°C 72H ; The humidity:50°C±3°C,90%±3% RH 72H	实验温度:60°C±3°C 72H/-10°C±3°C 72H; 实验湿度:50°C±3°C, 90%±3% RH 72H



ShenZhen Yes-Display International Technology CO.,LTD. 深圳市亿显国际科技有限公司			2.8 Inch UART Display Module 2.8 寸串口显示屏	
File NO.		REV	A/01	<a href="http://www.yes-display.com">http://www.yes-display.com</a>
certification	认证	ROHS 、 CE (EMI:EN55022 Class-B)	ROHS 、 CE 认证 ( EMI 等级:EN55022 ClassB 标准)	

### 5.6 Customized development service / 定制开发服务

Customized fee	定制费用	For free when the order > 300PCS	一次性签订 300PCS 合同,可免收定制费
Communication interface	通讯接口	Can customize parallel bus, RS485 and other external communication interface	可定制并行总线、RS485 等外通讯接口
hardware circuit	硬件电路	Customize PCB size and thickness, add board-level user circuit, select the specified TFT brand	定制 PCB 尺寸厚度、添加板级用户电路、选用指定 TFT 品牌
customization	功能定制	According to the user product custom special instructions or controls, reduce the user development difficulty	根据用户产品定制特殊指令或控件, 降低用户开发难度
Design service	美工服务	Can provide graphic design and product structure design services	可提供图片美工及产品结构设计服务
others	其它	Customized to meet all user needs	按需定制, 满足用户一切需求



## 6. Reliability Test Conditions and Methods / 可靠性实验测试

The serial port screen has undergone a series of reliability tests: high and low temperature, ESD, pulse, radiation, touch life, etc., to ensure product quality, as shown in the following figure:

串口屏经过一系列的可靠性实验测试: 高低温, ESD, 脉冲, 辐射, 触摸寿命等测试, 确保产品品质, 如下图所示:



## 7. PC Software(English Part)

### 7.1 UI\_Editor introduction







UI\_Editor.exe is a visual UI compiler provided by Yes-Display. Its function is to package images, text, configuration data and other information to be used by the UI to generate BIN files according to customer requirements. Customers can use UI\_Editor to make UI easily and quickly.







Notice: UI\_Editor is written in the environment of Microsoft.net Framework 4.6.2, so the computer system must be installed with Microsoft.net Framework 4.6.2 to work properly.

The interface for UI\_Editor consists of various buttons and screen frame, as shown below:



All UI design is completed in the screen frame, and users choose different functions to realize the design according to their needs. The detailed functions of the various function keys are as follows:

1.  Display text with images
2.  Image
3.  Button
4.  GIF
5.  Display numbers graphically
6.  Display text with font library
7.  QR code
8.  Tabulation

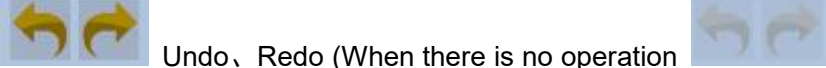
9.  Arc
10.  Progress bar
11.  SeekBar
12.  Rectangle、Rounded rectangle、Circle、Ellipse
13.  Straight line、Triangle、Quadrangle、Pentagon、Cylinder、Quadrangle prism
14.  Pointer
15.  Undo、Redo (When there is no operation)

There are several folders in the same folder as the UI\_Editor.exe, and their functions are shown below.

- FONT is for The font library needed to be used
- PICFILE is for the images needed to be used
- PROJECT is for backup the project files for each Save and Build
- SOURCE is for audio and cursor Bin files



图 2: UI\_Editor Folder

There are several folders in the PROJECT folder, and their action is shown below.

- BINFILE is contains the compiled BIN file, and the UserInfo and UartTFT\_Flash that need to be burned are stored here.
- COMMANDFILE is for project document
- PICFILE is for the compiled image files
- SRCPIC is for the original images

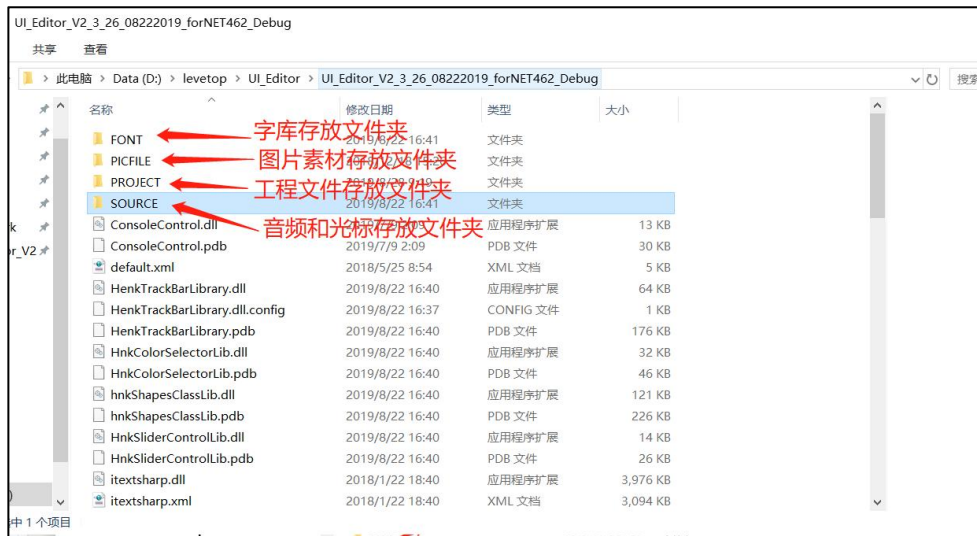
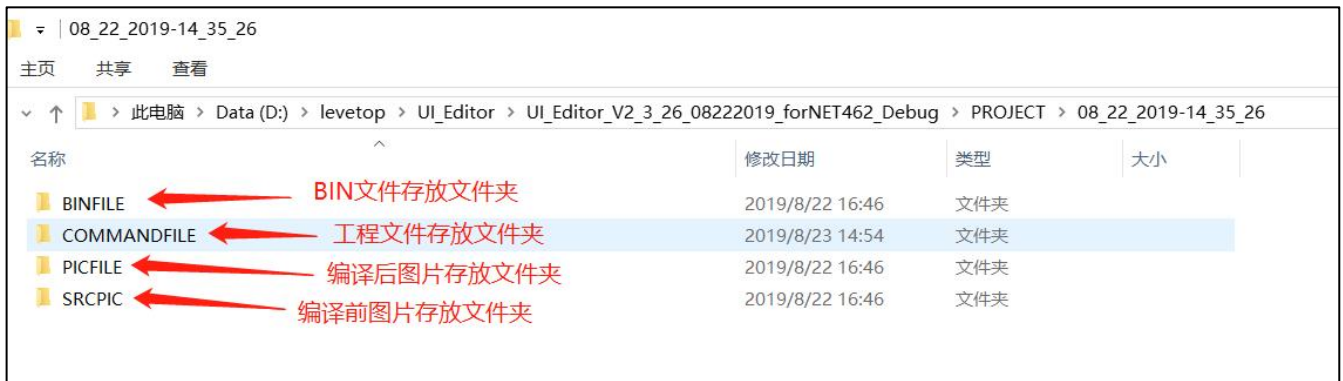

Figure 3: PROJECT folder

In Workspace options, there are three buttons: New Project, load and save. They are used to create a new project, load the project file, and save the current project. Press Save will save the project as a mainControlFiles.xml file in the COMMANDFILE folder of a time-named folder in PROJECT. The project can be reloaded by opening the maincontrolfiles.xml in the COMMANDFILE folder in the time-named folder with Load.



Figure4: UI\_Editor Reload Project File

## 7.2 Use UI\_Editor to design flow

The following figure is a detailed flowchart developed with UI\_Editor. Users can also download UI\_Editor demo (It7688\_ui\_editor\_demo.rar) from Yes-Display.com to understand the development mode more quickly. At the same time, it is recommended that the user first prepare the material according to the required function and TFT panel size. Because these images, GIF files, font library, audio files are stored in SPI Flash, the amount of data are not small. SPI Flash takes a long time to burn, so try to avoid repeatedly burning UartTFT\_Flash.bin during development, so as not to delay the development progress. Yes-Display's TFT Panel development demo board suite includes SPI Flash programmer, which can be downloaded from Yes-Display.com



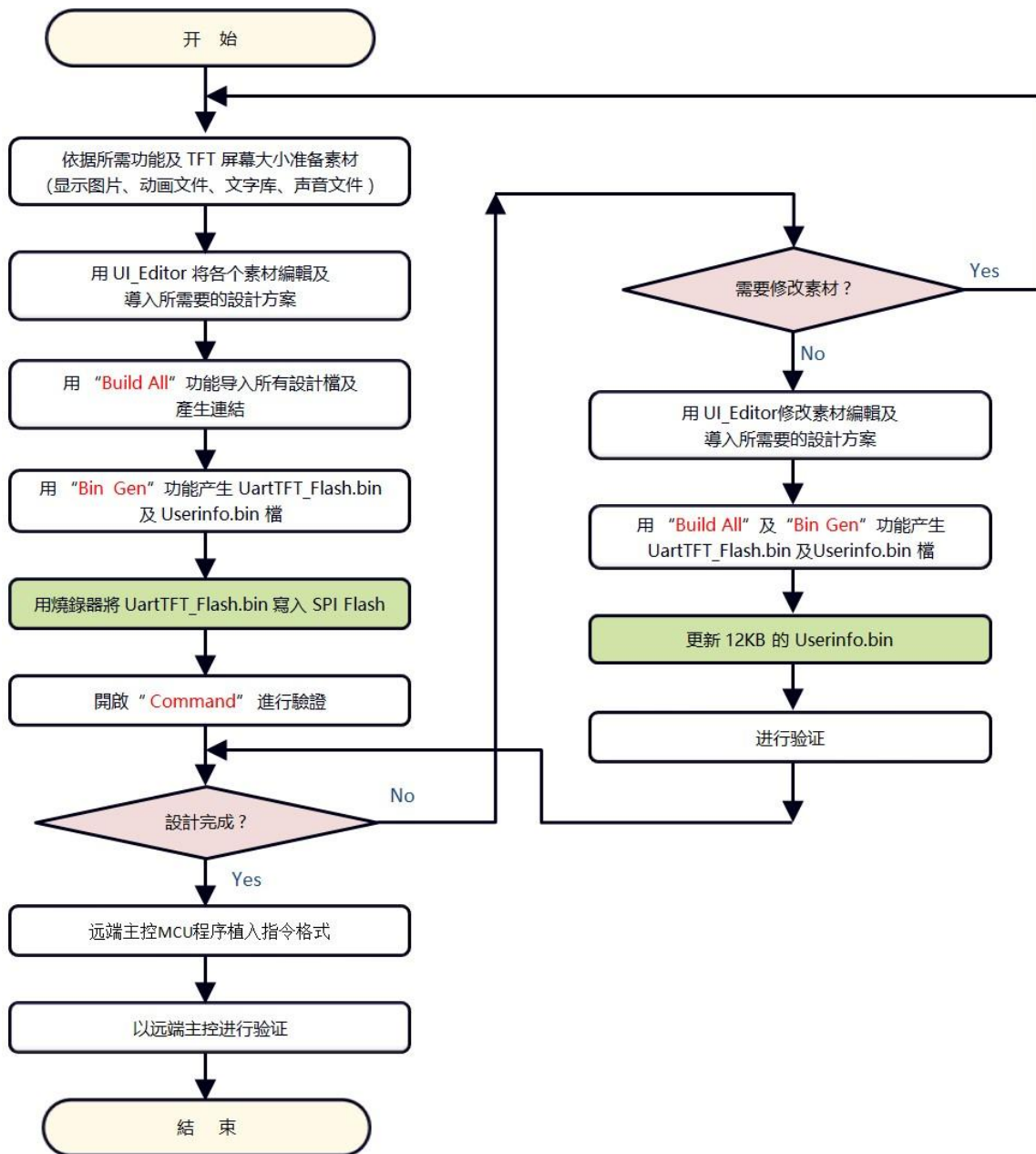

Figure 5: Design flow using UI\_Editor

## 7. UI 设计软件介绍 (中文部分)

### 7.1 UI\_Editor 介绍





UI\_Editor.exe 是一款以串口屏为对象的 图文 UI 编译器。它的功能是根据客户的需求，将串口屏要用到的图片、文字、配置数据等信息打包生成 BIN 档。客户可以使用 UI\_Editor 简单、快捷的制作 UI 界面，之后将生成的 BIN 文档烧录到 SPI Flash 中。











注意：UI\_Editor 是在 Microsoft .NET Framework 4.6.2 的环境中编写出来的，所以电脑系统必须安装 Microsoft .NET Framework 4.6.2 才能正常使用。

UI\_Editor 的界面由各种按钮和屏幕框组成，如下图所示：



所有的 UI 设计都在屏幕框内完成，用户根据需求选用不同的功能实现设计。其中各种功能键的详细功能如下：

-  在 UI\_Editor 上以图片形式显示文字
-  添加图片按钮
-  添加控件按钮
-  添加 GIF 图按钮
-  添加数字按钮（图片）

6.  添加文字按钮（字库）
7.  添加二维码按钮
8.  添加表格
9.  添加画圆环（任意角度）
10.  添加进度条按钮
11.  添加触控滑动条按钮
12.  分别是画矩形、画圆角矩形、画圆、画椭圆
13.  分别是画线、画三角形、画四边形、画五角形、画圆柱体、画长方体
14.  添加指针按钮
15.  分别是撤回操作和恢复操作按钮（当无任何操作时初始画面是 ）

与 UI\_Editor 工具同级的有几个文件夹，它们的作用如下图所示。

- FONT 文件夹用来存放需要使用的字库
- PICFILE 文件夹用来先存放需要使用到的图片文件
- PROJECT 文件夹备份着每次 Save 和 Build 的工程文件
- SOURCE 文件夹用来存放音频和光标 BIN 文件



图 2: UI\_Editor 工具同级文件目录

<b>ShenZhen Yes-Display International Technology CO.,LTD.</b> <b>深圳市亿显国际科技有限公司</b>			<b>2.8 Inch UART Display Module</b> <b>2.8 寸串口显示屏</b>		
<b>File NO.</b>		<b>REV</b>	<b>A/01</b>	<b>http://www.yes-display.com</b>	

PROJECT 文件夹下级的工程文件里有几个文件夹，它们的作用如下图所示。

- BINFILE 文件夹存放着编译好的 BIN 文件，需要烧录的 UserInfo 和 UartTFT\_Flash 就存放在此处。
- COMMANDFILE 文件夹存放着工程储存文件
- PICFILE 文件夹存放着编译后的图片文件
- SRCPIC 文件夹存放着编译前的图片

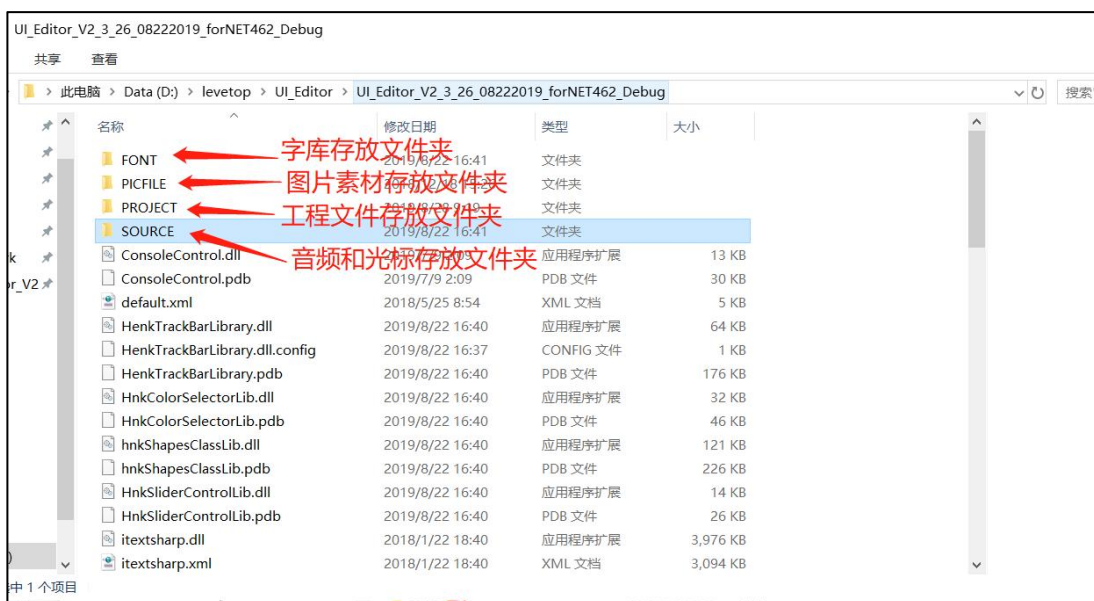

图 3: PROJECT 文件夹下级的工程文件目录

ShenZhen Yes-Display International Technology CO.,LTD. 深圳市亿显国际科技有限公司			2.8 Inch UART Display Module 2.8 寸串口显示屏		
File NO.		REV	A/01	http://www.yes-display.com	

在菜单按钮里，有 New Project、load 和 save 三个按钮。分别用来创建新工程、装载工程文件、保存当前工程。按 save 按钮会把工程以 mainControlFiles.xml 文件保存在 PROJECT 下级中以时间命名的 COMMANDFILE 文件夹里。使用 Load 功能在 PROJECT 下级找到对应时间的文件夹里 COMMANDFILE 文件夹的 mainControlFiles.xml 文件，就可以重新加载工程。



图 4: UI\_Editor 重装载工程文件

## 7.2 使用 UI\_Editor 的设计流程

下图为用图文 UI 编译器 (UI\_Editor.exe) 开发的详细流程图，将更快速的了解开发模式。同时建议用户先依据所需功能及 TFT 屏幕大小准备好素材，因为这些显示图片、动画文件、文字库、声音文件等是存放在 SPI Flash 内，资料量都不小，而 SPI Flash 的烧录所需时间较长，因此尽量避免开发中反复对 SPI Flash 进行 UartTFT\_Flash.bin 档的烧写，以免延误开发效率。



图 5：使用 UI\_Editor 的设计流程



## 8. Packing Method

### 8.1 Packing Method

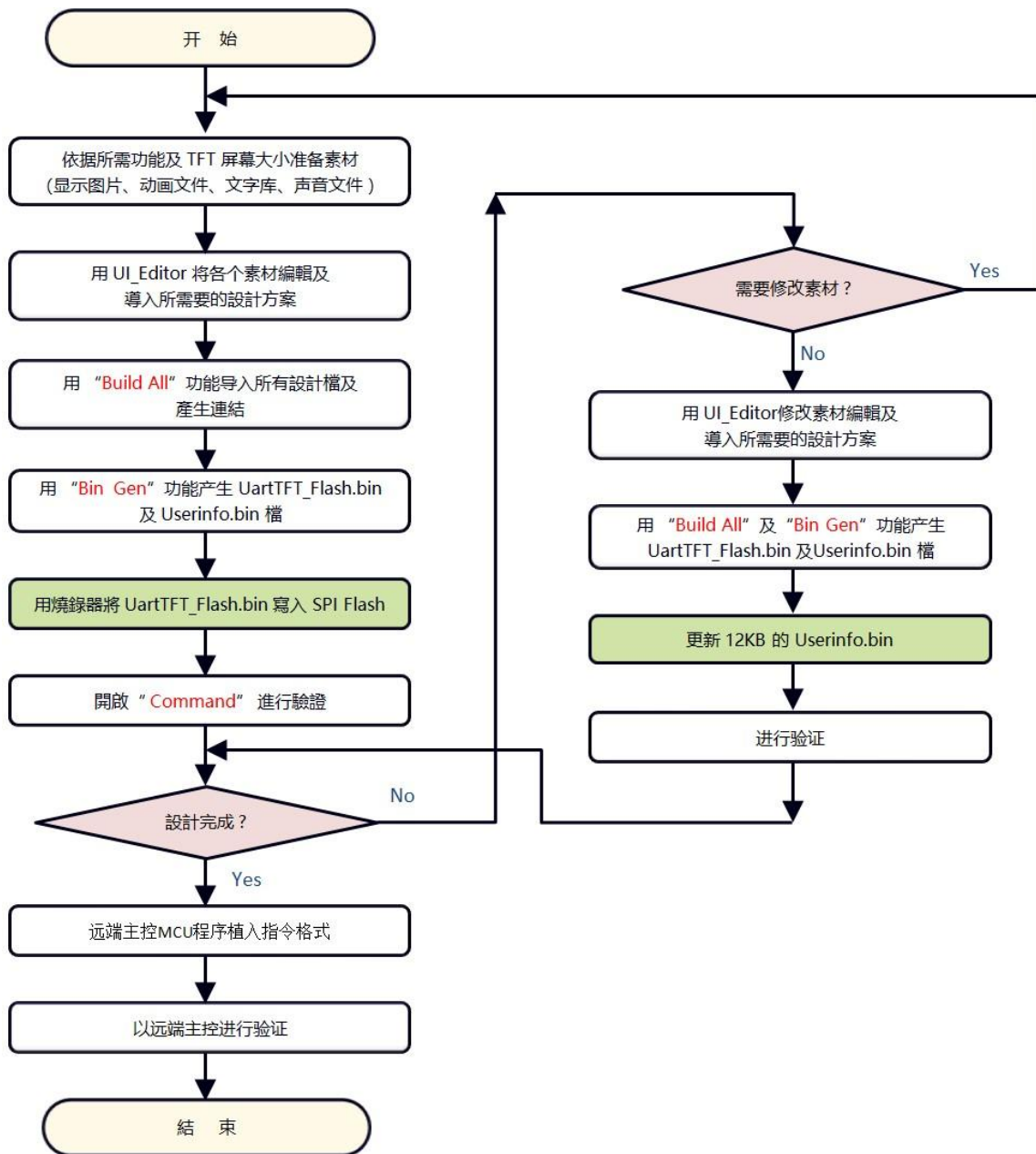
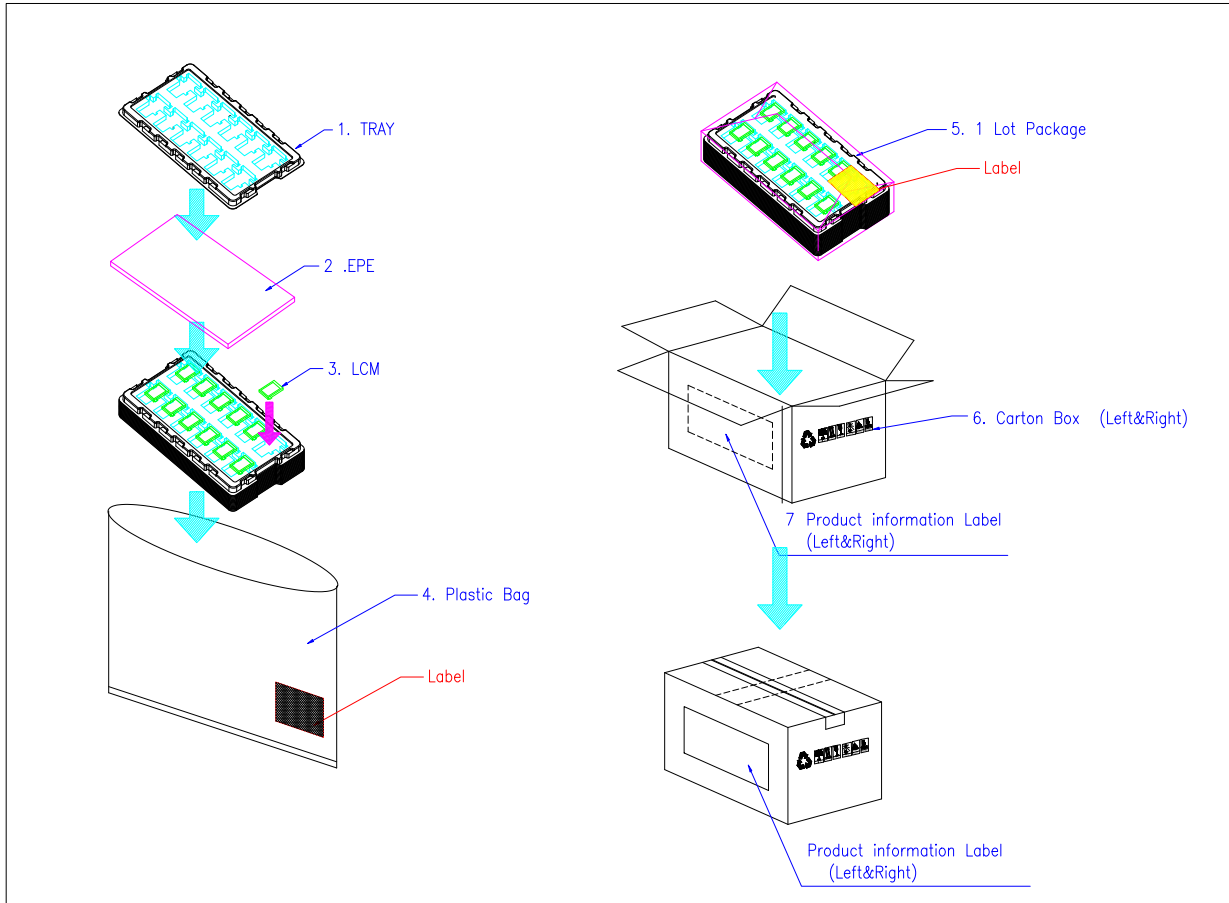

### 8.2 Packing Label

TBD